

721. An application of μ -synthesis for control of a small air vehicle and simulation results

Arkadiusz Mystkowski

Faculty of Mechanical Engineering, Bialystok University of Technology, Wiejska 45C, Bialystok, Poland

E-mail: a.mystkowski@pb.edu.pl

(Received 11 September 2011; accepted 14 February 2012)

Abstract. This paper discusses a nonlinear robust control design procedure to micro air vehicle that combines the singular value (μ) and μ -synthesis technique, which overcomes structured uncertainty of the control plant and is valid over the entire flight envelope. The uncertainty model consists with multiplicative plug-in dynamics disturbances and parametric uncertainty. The uncertainty is conducted with the aircraft aerodynamics characteristics and parameters. These uncertainties are bounded in size based on wind tunnel experiments, flight test and analytical calculations. Furthermore, these investigations allow us to obtain the linearized model of the aircraft called here nominal model.

Keywords: micro air vehicle, μ -synthesis approach, structured uncertainty, weighting functions.

Introduction

Controller design for small air vehicles requires overcoming many characteristics that are specific to these flying aircrafts such as open-loop instability, very fast dynamics, nonlinear behaviour and high degree of coupling among different state vectors. What is more, dynamics of micro aircraft has an uncertainty effect that makes the model dynamics is changing during the flight and parametric uncertainty which means that air vehicle model is a parameter time-variant (PTV) [1].

Most initial attempts to achieve stable autonomous flight have been based on PID controller design. Many commercial autopilots such as Procerus's Kestrel [2] or Micropilot's MP2128 [3] are based on PID controllers. The main advantage of PID control is that controller parameters may be easily adjusted when the model is not exactly known. This is a cheap and fast technique, where the PID controller parameters can be tuning on-line during test flight. However, in spite of such advantages, the PID control method does not perfectly cancel system dynamics because of uncertainty in the aircraft dynamics forces and moments. Furthermore, the PID controllers are of the SISO type, it is assumed that controlled states are not strongly coupled.

The development of robust control techniques in the eighties has revolutionized flight control design. In order to overcome difficulties connected with the micro air vehicle control system, the complicated nonlinear robust control methods based on the H-infinity and μ -synthesis approaches are commonly used [4-6]. These techniques completely solve the problem of controlling uncertain systems by uncertainty independent controllers which guarantees the design requirements due to limitation of actuator's dynamics. However, these uncertainties are bounded in size by some well-defined functions in frequency domain. Generalized H-infinity (H_∞) control developed by Glover and Doyle [7] is employed to minimize the infinity norm of the error transfer function. In this approach, structured uncertainty, external disturbance, noise and signals limits are considered. The μ -synthesis control is an extension to the H-infinity optimal control technique. This method measures the robustness of a system and combines with the H-infinity control technique in an attempt to structure the uncertainty in the system model. Therefore, obtained controller is robust to a more realistic class of perturbations, thus being less conservative and having more flexibility to achieve a higher level of control performances. However, this method requires a detailed control plant with structured uncertainly knowledge. Also, the μ -synthesis method generates a high-order controller. The controller finding process requires iterative cycles to get the optimum solution.

This paper discusses a nonlinear robust control design procedure to unmanned aerial vehicle (UAV) that combines the singular value (μ) and μ -synthesis technique, which overcomes structured uncertainty of the control plant and is valid over the entire flight envelope. The uncertainty model consists with multiplicative plug-in dynamics disturbances and parametric uncertainty. The uncertainty is conducted with the aircraft aerodynamics characteristics and parameters. These uncertainties are bounded in size based on wind tunnel experiments, flight test and analytical calculations. Furthermore, these investigations allow to obtain the linearized model of the aircraft called here nominal model.

BELL540 dynamics

The micro air vehicle (MAV) examined in this paper is called BELL540 [8]. It was built and equipped with autopilot (Kestrel [2]) electronics by the group of Automatic and Robotics Department. It is a small, 0.84 m wingspan, total weight including all instrumentation “ready to flight status” equal to 1.2 kg and chord length is equal to 0.57 m (NACA 0012 modification profile), see Fig. 1. The control is accomplished using a set of aileron and elevator control surfaces.

Thus, the airplane control system allows to control the lateral-directional and longitudinal-directional dynamics. The full model has three control inputs: aileron, elevator and throttle. The measured outputs e.g. in case of lateral-directional control are: roll, roll rate, yaw rate and lateral velocity.

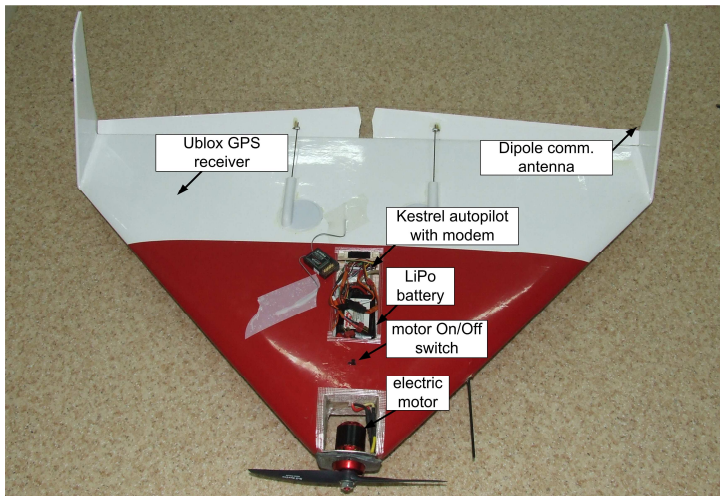

Fig. 1. UAV platform - BELL540

In order to design control law, the nominal model of the BELL540 flying delta wing airplane is calculated. First, the dynamics of the BELL540 is decoupled into lateral dynamics and longitudinal dynamics. The lateral dynamics are the MAV’s response along the roll and yaw axes, and it is excited with aileron input. The longitudinal dynamics are the airplane response along the pitch axis, and are excited with elevator and throttle inputs. For example the state-space representation for the longitudinal motion is given by [9]:

$$\begin{bmatrix} \dot{u} \\ \dot{w} \\ \dot{q} \\ \dot{\theta} \end{bmatrix} = \mathbf{A} \begin{bmatrix} u \\ w \\ q \\ \theta \end{bmatrix} + \mathbf{B} \begin{bmatrix} \delta_e \\ \delta_p \end{bmatrix} \mathbf{u}, \quad \mathbf{y} = \mathbf{C} \begin{bmatrix} u \\ w \\ q \\ \theta \end{bmatrix} \quad (1)$$

where:

$$\mathbf{A} = \begin{bmatrix} \frac{X_u}{m} & \frac{X_w}{m} & 0 & -g \cos \theta_0 \\ \frac{Z_u}{m - Z_w} & \frac{Z_w}{m - Z_w} & \frac{Z_q + mU_0}{m - Z_w} & \frac{-mg \sin \theta_0}{m - Z_w} \\ I_{yy}^{-1} [M_u + Z_u \Gamma] & I_{yy}^{-1} [M_w + Z_w \Gamma] & I_{yy}^{-1} [M_q + (Z_q + mU_0) \Gamma] & -I_{yy}^{-1} mg \sin \theta \Gamma \\ 0 & 0 & 1 & 0 \end{bmatrix}$$

$$\mathbf{B} = \begin{bmatrix} \frac{X_{\delta_e}}{m} & \frac{X_{\delta_p}}{m} \\ \frac{Z_{\delta_e}}{m - Z_w} & \frac{Z_{\delta_p}}{m - Z_w} \\ I_{yy}^{-1} [M_{\delta_e} + Z_{\delta_e} \Gamma] & I_{yy}^{-1} [M_{\delta_p} + Z_{\delta_p} \Gamma] \\ 0 & 0 \end{bmatrix}, \quad X_u = \frac{\partial X}{\partial u}, \dots, \Gamma = \frac{M_w}{m - Z_w}.$$

The coefficients data for Eqn. (1) are provided in the project's report [10]. The inputs of the model are following control surfaces: aileron, elevator, and throttle. Where, the outputs are the MAV states due to body frame's coordinates $[X, Y, Z]$. The longitudinal state vector consists with $[u, w, q, \theta, h]$, where: u – velocity along X [m/s], w – velocity along Z [m/s], q – pitch rate [rad/s], θ – pitch angle [rad], and h – altitude [m]. The lateral state vector is given by $[v, p, r, \phi]$, where: v – velocity along Y [m/s], p – roll rate [rad/s], r – yaw rate [rad/s], and ϕ – roll angle [rad]. For the further simulations only the longitudinal airplane model will be consider.

Weighting functions

Note that μ -synthesis method combines H-infinity algorithms seek to minimize the largest closed-loop gain across frequency. To apply this tool, all design tradeoffs and frequency-depended specification as constraints on the closed-loop gains must be recast. The weighting functions are used to capture the limits on the aileron, elevator and thrust actuators deflection magnitude and rate. The design goal is to have the "true" airplane respond effectively to the autopilot's elevator stick inputs. These performance specifications include weighting functions putted on the elevator output, noise weighting and anti-aliasing filters of measured signals. The elevator stabilizer actuator has +/- 20 degs and +/- 90 degs/sec limits on their deflection and deflection rate. To capture the limits on the elevator deflection magnitude and rate, the weighting function such as $W_{elevator}$ is picked, and used to penalize the actuation effort. The noise weight such as high-pass filter W_{noise} is used to model the frequency content of the sensor noise in the all measured channels. All measured signals are filtered by the second-order anti-aliasing filters. The three weighting functions are shown in the interconnection given in Fig. 4 and given as:

$$W_{elevator}(s) = \frac{0.3491s}{s + 0.3491}, \quad W_{noise}(s) = \frac{0.0125s + 0.0125}{s + 100}, \quad W_{filter}(s) = \frac{6672}{s^2 + 98.02s + 6672} \quad (2)$$

Model uncertainty

The main advantage of using the μ -synthesis control here is in handling structured uncertainty. The uncertainty is described by unknown, structured, norm-bounded perturbations, which act on the nominal control model via a linear fractional transformation (LFT). In this work, the uncertainty model consists of the unmodeled MAV's dynamics, nonlinear states (e.g. stall) and parameter perturbations during flight time. The uncertainty is introduced as

multiplicative $W_{un} \cdot \Delta$ at the nominal plant P_0 input, where the error dynamics Δ have gain less than 1 across frequencies, and the weighting function W_{un} reflects the frequency ranges in which the model is more or less accurate. The multiplicative uncertainty model is given as [7]:

$$|\Delta(s)| = \frac{|P(s) - P_0(s)|}{P_0(s)} \leq W_{un}(s) \quad (3)$$

where: Δ – uncertainty, P_0 – nominal plant, P – real plant, W_{un} – uncertainty bound function.

The weighting function W_{un} is a high pass that the total perturbation is 5% at lower frequency and increases to 100% above the 100 rad/s, see Fig. 2.

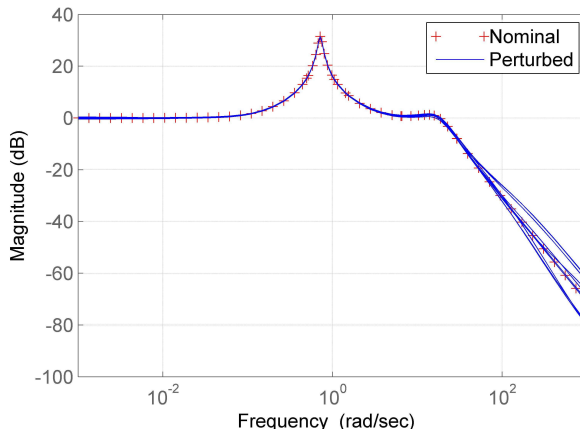

Fig. 2. Nominal model and perturbations between elevator input and pitch angle output

μ -synthesis control design

The μ -synthesis control permits to design the multivariable optimal robust controller for complex linear systems with any type of the uncertainties in their structure. The μ -synthesis controller was calculated by using tools of Robust Control Toolbox™ of Matlab [11]. The command *dksyn* allows to perform the synthesis and set the frequency grid used for μ -synthesis. The μ -synthesis control system structure is given in Fig. 3.

The μ -controller is calculating during recurrence algorithm which seeks matrix \mathbf{D} , that the following condition is passed [12]:

$$\left\| \mathbf{D} T_{y_1 u_1} \mathbf{D}^{-1} \right\|_{\infty} \leq 1 \quad (4)$$

where: $\mathbf{D}(s) = \text{diag}(d_1(s)I_{k_1}, \dots, d_n(s)I_{k_n})$, and $T_{y_1 u_1}$ – closed loop function.

The algorithm consists of 4 steps:

1) The $\|H\|_{\infty}$ norm is used to find \mathbf{D} -model that fulfils the condition as follows:

$$\left\| \mathbf{D} T_{y_1 u_1} \mathbf{D}^{-1} \right\|_{\infty} = \min \quad (5)$$

2) Then, the singular value μ of the closed loop function $T_{y_1 u_1}$ is calculated.

3) Next, the μ -controller is carried out by calculating the following cost function [12]:

$$\mu = \min_{D(j\omega)} \bar{\sigma}(\mathbf{D}(j\omega)T_{y_1 u_1}(j\omega)\mathbf{D}^{-1}(j\omega)) \quad (6)$$

- 4) If the μ -controller satisfy the condition (6) the recurrence algorithm is stopped otherwise goes to step 1.

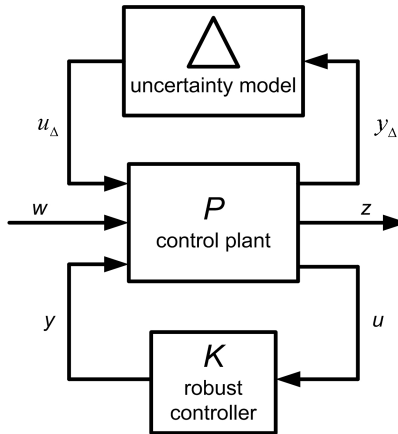

Fig. 3. Scheme of the μ -synthesis control model [7], y – feedback signal, u – control signal, u_Δ , y_Δ – output and input of uncertainty model, w – reference, z – measurements

The μ -controller synthesized for the augmented plant model must meet the analysis objectives presented by the maximal singular value. Finally, the augmented model of the micro air vehicle, which consists from the real control model and weighting functions, was carried out. The controller design study was performed for the simulation augmented model with the structure given in the Fig. 4.

Simulation results

The simulation model was a nominal model with uncertainties, weighting functions, including actuator dynamics and limits, noise, and control disturbances.

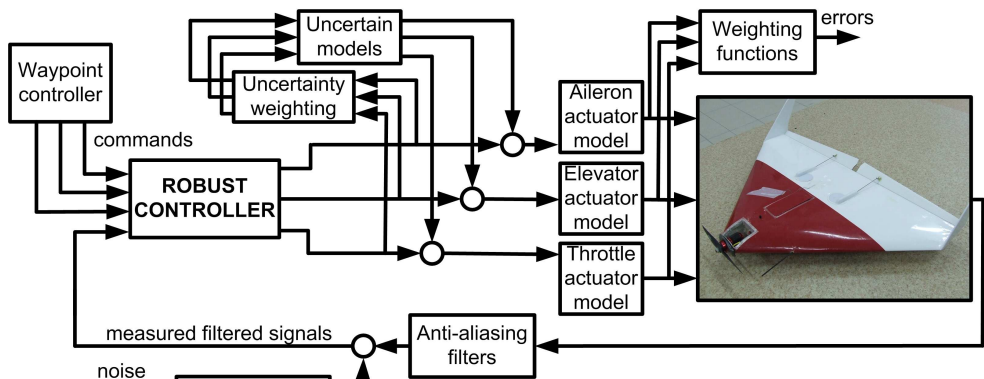

Fig. 4. MAV robust control system architecture

The nominal linearized airplane model is found at an angle-of-attack of 5 degrees, flying at an altitude of 50 m with airspeed of 15 m/s.

The main disadvantage of the μ -synthesis control is that obtained controller has a high order. Therefore, the order of the μ -controller must be reduced before implementation in the real-time digital processor. In this case the μ -controller is reduced to 6th order by using the Balancing Truncation Method [13]. The transfer function between control signal and error signal of the controller has the following form:

$$K(s) = \frac{U(s)}{E(s)} = \frac{a_6s^6 + a_5s^5 + a_4s^4 + a_3s^3 + a_2s^2 + a_1s + a_0}{b_6s^6 + b_5s^5 + b_4s^4 + b_3s^3 + b_2s^2 + b_1s + b_0}. \quad (7)$$

The differential linear representation of the transfer function (9) is as follows:

$$b_6 \frac{d^6u}{dt^6} + b_5 \frac{d^5u}{dt^5} + \dots + b_1 \frac{du}{dt} + b_0u = e_6 \frac{d^6e}{dt^6} + e_5 \frac{d^5e}{dt^5} + \dots + a_1 \frac{de}{dt} + a_0e. \quad (8)$$

In order to implement the robust controller in the real microprocessor, the control algorithm should be realized as digital representation with fixed sample period T . Therefore, all of the subsequent differentials (8) should be discretized for the i -th time step. The formulas of discrete representations of differentials for continuous functions $u(t)$ and $e(t)$ are the same. For example, the discrete differentials for $u(t)$ are good known and given by:

$$\begin{aligned} \frac{du}{dt} &\approx \frac{u(i) - u(i-1)}{T}, \dots, \\ \frac{d^6u}{dt^6} &\approx \frac{u(i) - 6u(i-1) + 15u(i-2) - 20u(i-3) + 15u(i-4) - 6u(i-5) + u(i-6)}{T^6}. \end{aligned} \quad (9)$$

After substituting discrete differentials (9) to Eqn. (8) and making some mathematical calculation the effort signal $u(i)$ of the robust controller is calculated from the recurrence algorithm as follows:

$$u(i) = C_1u(i-1) + C_2u(i-2) + C_3u(i-3) + C_4u(i-4) + C_5u(i-5) + C_6u(i-6) + C_7e(i) + C_8e(i-1) + C_9e(i-2) + C_{10}e(i-3) + C_{11}e(i-4) + C_{12}e(i-5) + C_{13}e(i-6), \quad (10)$$

$$\begin{aligned} \text{where: } C_1 &= -\frac{B_1}{B_0}, C_2 = -\frac{B_2}{B_0}, C_3 = -\frac{B_3}{B_0}, \dots, C_{11} = \frac{A_4}{B_0}, C_{12} = \frac{A_5}{B_0}, C_{13} = \frac{A_6}{B_0}, \\ B_0 &= \frac{b_6}{T^6} + \frac{b_5}{T^5} + \frac{b_4}{T^4} + \frac{b_3}{T^3} + \frac{b_2}{T^2} + \frac{b_1}{T} + b_0, B_1 = -\frac{6b_6}{T^6} - \frac{5b_5}{T^5} - \frac{4b_4}{T^4} - \frac{3b_3}{T^3} - \frac{2b_2}{T^2} - \frac{b_1}{T}, \dots, \\ B_5 &= -\frac{6b_6}{T^6} - \frac{b_5}{T^5}, B_6 = \frac{b_6}{T^6}, \\ A_0 &= \frac{a_6}{T^6} + \frac{a_5}{T^5} + \frac{a_4}{T^4} + \frac{a_3}{T^3} + \frac{a_2}{T^2} + \frac{a_1}{T} + a_0, A_1 = -\frac{6a_6}{T^6} - \frac{5a_5}{T^5} - \frac{4a_4}{T^4} - \frac{3a_3}{T^3} - \frac{2a_2}{T^2} - \frac{a_1}{T}, \dots, \\ A_5 &= -\frac{6a_6}{T^6} - \frac{a_5}{T^5}, A_6 = \frac{a_6}{T^6}. \end{aligned}$$

Then, the digital robust control algorithm Eqn. (10) was implemented in the Rabbit RCM3400 microprocessor, 8-bit, 29 Mhz clock, and the control loop frequency equal to 100 Hz.

Matlab simulations

The μ -synthesis controller was performed to check if the specs can be met robustly when taking into account the uncertainty Δ . The best μ -controller can keep the closed-loop gain below $bound = 1.31$ for the specified model uncertainty, indicating that the specs can be nearly but not fully met for the family of aircraft models under consideration. The $bound$ corresponds to the μ value (robust performance), see Fig. 5a. Then, the performance and robustness of the μ -controller are compared for the nominal and worst-case performance (peak gain < 1).

Recall that the performance specs are achieved when the closed loop gain is less than 1 for every frequency, see Fig. 5b. The Fig. 5b shows that the μ -controller has not met the performance specs but maintains this performance consistently for all perturbed models (worst-case gain near 1.31), where its performance can sharply deteriorate (peak gain near 15) for some perturbed model within error bound.

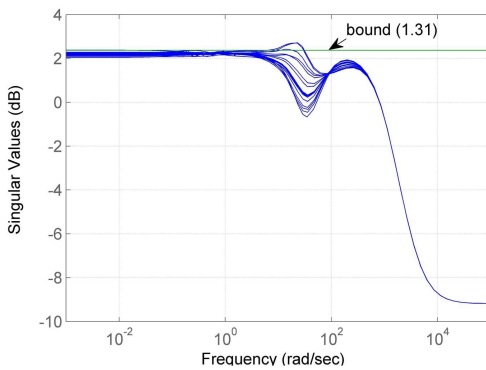

Fig. 5a. Sigma plot for closed-loop

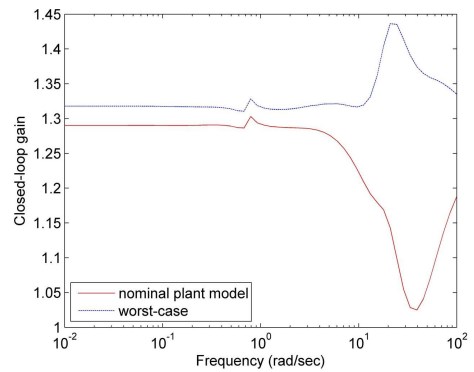

Fig. 5b. Robust performances plot for closed-loop

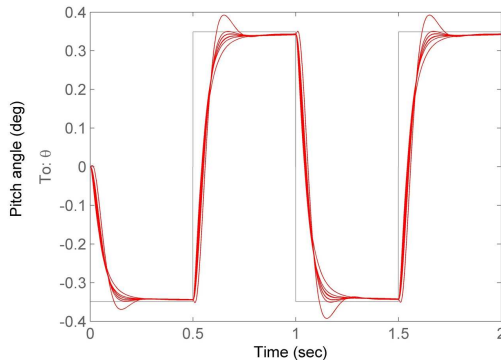

Fig. 6a. Pitch angle response

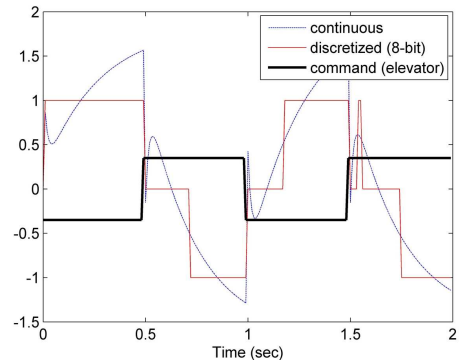

Fig. 6b. Effort control signal

Next, the time-domain validation (robustness test) of the μ -controller is presented. The “true” closed-loop airplane model response to elevator deflection ± 20 deg (± 0.3491 rad) is calculated. Totally, 10 plots results from the combination of the Δ are presented in the Fig. 6a. The effort signal (Eqn. 10) of the discretized μ -controller is compared with continuous one (see Fig. 6b).

Conclusions

This paper presents a detailed longitudinal-directional control of micro aircraft using μ -synthesis control. The designed controller is robustly stable, where robustly means stability for

any perturbed aircraft model consistent with the modelling error (uncertainty) bound. Since the μ -synthesis control system must then be verified, the Matlab simulations are performed and presented. Refer to Fig. 5a and 5b that show a good tracking performance of the pitch angle to a series of step commanded deflection. The μ -controller maintains robust performances for all perturbed models Δ .

Acknowledgements

The research work is financed by the Polish Ministry of Science and Higher Education as part of the ordered Research Project No. O R00 0029 11 conducted in the years: 2010÷2012.

References

- [1] **Aguiar A. P., Hespanha J. P.** Trajectory-tracking and path-following of under-actuated autonomous vehicles with parametric modeling uncertainty. *IEEE Tran. on Aut. Con.*, Vol. 52, 2007, p. 1362-1379.
- [2] Procerus Inc., <http://www.procerus.com>
- [3] Micropilot Inc., <http://www.micro-pilot.com>
- [4] **Amato F., Cosentino C., Iervolino R., Ciniglio U.** Robust H_∞ control of a fly-by-wire aircraft: an LFT approach, in CCA 2003. *Proc. of 2003 IEEE Con. on Con. App.*, Vol. 1, 2003, p. 200-205.
- [5] **Sadraey M., Colgren R.** Robust nonlinear controller design for a complete UAV mission. *AIAA Guidance, Navigation, and Control Conference and Exhibit*, 21-24 August, 2006, p. 1-20.
- [6] **Sadraey M., Colgren R.** Two DOF robust nonlinear autopilot design for a small UAV using a combination of dynamic inversion and H_∞ loop shaping. *AIAA Guidance, Navigation, and Control Conference and Exhibit*, 15-18 August, 2005, p. 1-21.
- [7] **Zhou K., Doyle J. C., Glover K.** *Robust and Optimal Control*. Prentice Hall, 1996.
- [8] <http://www.topmodelcz.cz>
- [9] **Etkin B., Reid L. D.** *Dynamics of Flight, Stability and Control*. 3rd ed., John Wiley&Sons, 1996.
- [10] **Mystkowski A.** The robust control of unmanned aerial vehicle. Research project No. O R00 0029 11, Report, 2011, p. 1-15.
- [11] Mathworks Inc., <http://www.mathworks.com>
- [12] **Balas G. J., Packard A. K., Harduvel J. T.** Application of μ -synthesis techniques to momentum management and attitude control of the space station. *AIAA Guidance, Navigation and Control Conference*, New Orleans, August 1991.
- [13] **Silverman L. M., Bettayeb M.** Optimal Approximation of Linear Systems. *Proc. American Control Conf.*, San Francisco, CA, 1980.