

551. Application of free vibration technique for evaluation of vibro-isolation properties of pipe fixing elements

R. Ramanauskas, V. Augutis, M. Malcius, D. Gailius

Kaunas University of Technology, Studentų g. 50, Kaunas, Lithuania

E-mail: ramūnas.ramanauskas@ktu.lt, marius.malcius@gmail.com, vygantas.augutis@ktu.lt

(Received 02 June 2010; accepted 10 September 2010)

Abstract. One approach for reducing noises in pipeline transport systems is selection of appropriate fasteners. Therefore, it is important to know vibro-acoustic characteristics of the fastening elements. This paper proposes a measurement system for determination of dynamic properties of pipe fastening elements and describes performed experiments that demonstrate characteristics dependence on clamping force, construction of the holder and its vibration modes.

Keywords: pipe vibrations, fastening element, vibration modes, dynamic properties.

Introduction

One of the main causes of discomfort in industrial and residential facilities is high level of structure born sound (noise). The vibrations can be generated due to operation of mechanical equipment or by surrounding people. Usually the heating, ventilation and plumbing systems cause the largest part of structure born noise [1]. Noise in these systems could be generated by many different equipment or other factors - pumps, valves, flow imbalances and others. One way to reduce noises in flow systems is to reduce the sources of noise. However, this is not always possible. Another option is to prevent the propagation of generated vibrations in the piping itself by improving its vibro-isolation. For this purpose vibration attenuating tubes (e.g. Wavin Asta) might be used, pipes could be wrapped in sound insulating materials (e.g. fiberglass) or vibrations might be damped (or alternatively – better isolated from the walls) by choosing an appropriate pipe clamping elements. Pipe holder is one of the main elements, which influences how vibrations are propagated along the pipe or transferred to the wall. It is difficult to define what requirements should be met by a "good" pipe holder. This article will review one of the methods for evaluation of vibro-acoustic properties of pipe holders.

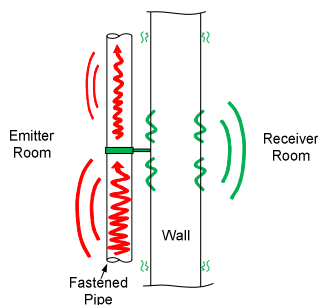

Fig. 1. Vibration propagation from a pipe to a wall

Depending on pipe parameters (diameter and material), there can be several vibration modes (Fig. 2) which produce different movement patterns near (in) a pipe holder, which in turn leads to a distinctive wall vibrations. Several main vibration types of clamping element could be distinguished: cross-longitudinal (Fig. 3a) linear and rotary movements (Fig. 3b, c, d).

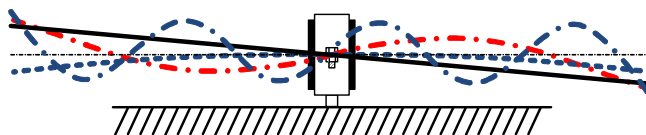

Fig. 2. Simplified view of different vibration modes

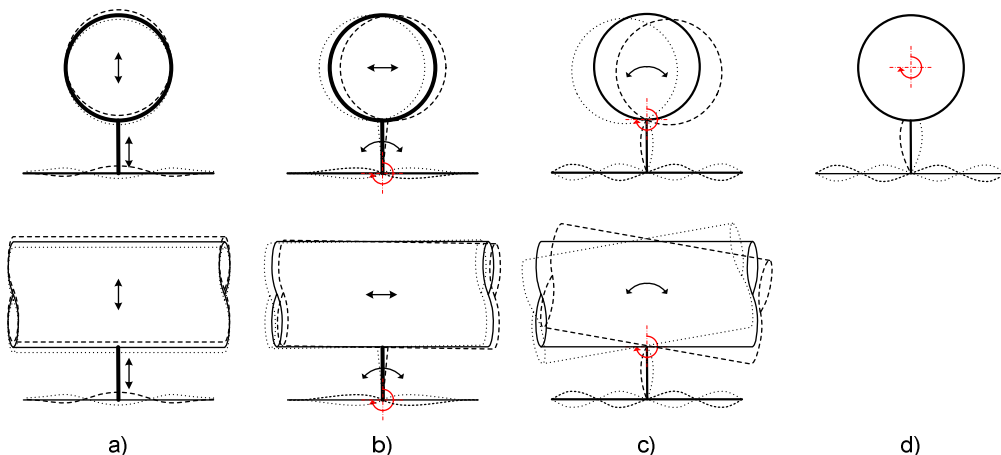

Fig. 3. Main vibration mode shapes for the cross-section and the longitudinal section of a pipe due to various wave types

Several tests were proposed to characterize possible vibro-acoustic behavior of pipe fixing elements: transfer function measurement, dynamic tests for determination of dynamic properties of the pipe fixing elements and static or quasi-static tension-compression tests [2].

Dynamic properties (stiffness, damping) of the pipe fixing element structures (particularly for the rubber elements) can significantly differ from the static ones thus dynamic measurement techniques are needed.

Theoretical approach

The behavior of the vibrating structure may be described by its dynamic model. By measuring the resonance frequency and bandwidth, we can evaluate the system stiffness and damping, for the certain vibration shape (mode).

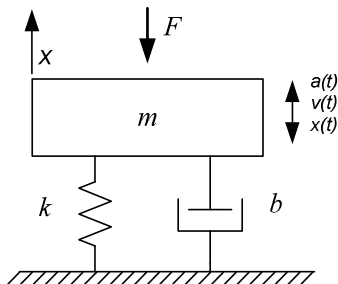

Fig. 4. Simple dynamic model of a pipe holding system

Equation of system motion [3, 4]:

$$\ddot{x} + \frac{b}{m} \dot{x} + \frac{k}{m} x = 0 \quad (1)$$

Where m - mass of the pipe, k - stiffness of fastening element, b - damping.

Assuming $\frac{k}{m} = \omega^2$, equation (1) can be written as:

$$\ddot{x} + \frac{b}{m} \cdot \sqrt{\frac{m}{k}} \cdot \omega \cdot \dot{x} + \omega^2 x = 0 \quad \text{or} \quad \ddot{x} + 2\zeta \cdot \omega \cdot \dot{x} + \omega^2 x = 0, \quad (2)$$

where $\zeta = \frac{1}{2} \frac{b}{\sqrt{k \cdot m}}$ is damping factor.

Resonance analysis can be applied for vibrating system analysis. After external excitation vibration magnitude of a system reaches maximum at resonant frequency:

$$\omega_r = \sqrt{1 - 2\zeta^2} \omega_n, \quad (3)$$

where ω_n - natural angular frequency of the system. ω_r and ω_n are almost equal for small ζ (i.e., for light damping).

Frequency transfer function may be used to determine the damping ratio. The Q-factor, which measures the sharpness of resonant peak, is defined by

$$Q = \frac{\omega_r}{\Delta\omega} = \frac{1}{2\zeta} = \frac{b}{\omega_r \cdot m} \quad (4)$$

Then equation (2) can be written as:

$$\ddot{x} + Q \cdot \omega_n \cdot \dot{x} + \omega_n^2 x = 0 \quad (5)$$

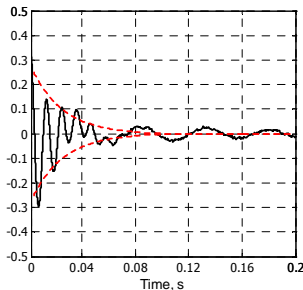

Fig. 5. Free vibration with damping

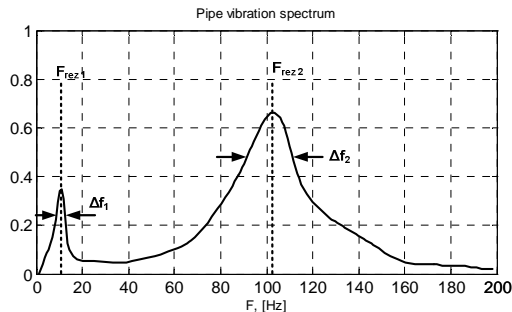

Fig. 6. Resonance curve from the free vibration test

Therefore, vibrating system parameters (stiffness and damping) can be evaluated by free vibration method. It can be performed in time (stiffness is estimated from swing frequency, damping from decaying exponent) or frequency domain (resonant frequency corresponds to stiffness, bandwidth corresponds to damping). Because system of interest oscillates in several modes (Fig 2-3), analysis in time domain is complicated (Fig. 5). Therefore dynamic properties of the system are simpler to evaluate from vibrations spectrum (Fig. 6).

Stiffness (for linear vibrations):

$$k = \omega_r^2 m = (2\pi \cdot F_r)^2 m, \quad [\text{N/m}] \quad (6)$$

Stiffness (for rotational vibrations)

$$k_{rot} = \omega_r^2 J = (2\pi \cdot F_r)^2 J, \quad [\text{N m/rad}], \quad (7)$$

where ω_r , F_r is system resonant frequency, J - moment of inertia.
 For the cylindrical body the inertia moment is equal to

$$J = \frac{m}{12} \sqrt{3R^2 + L^2} \quad (8)$$

where m - mass of the cylinder;
 R - radius of the cylinder;
 L - length of the cylinder.

Damping factor (for linear vibrations)

$$b = 2\pi \cdot \Delta_f \cdot m = \frac{\omega_r}{Q} \cdot m \quad (9)$$

Damping factor (for radial vibrations)

$$b_{rot} = 2\pi \cdot \Delta_f \cdot J = \frac{\omega_r}{Q} \cdot J \quad (10)$$

where F_r - resonance frequency,
 Δ_f - bandwidth of the resonance curve.

Experiments and analysis method

In most cases the pipe is vibrating in several different modes. It is not easy to tell what mode corresponds to the particular spectral peak. It may also happen that vibration modes are tightly coupled, which makes it difficult to evaluate the resonance curve parameters (resonant frequency and bandwidth Δf). Additional steps should be performed in order to determine what spectral peaks correspond to particular modes. For spectral identification advanced knowledge on the nature of vibrations could also be helpful.

In real-life conditions, vibrations of the pipe depend on many factors such as: material of the pipe and its filling, properties of pipe fixing element, wall properties, other nearby structural elements. Pipes on which experiments were performed are short and this causes reflections and additional modes of vibration [5]. To minimize the influence of the multiple factors, the test setup with simplified structure was selected. Instead of pipe the pipe imitator (the steel cylinder) was used. This reduces number of vibration modes in audible frequency range. In our research we have evaluated parameters for the first 4 vibration modes. The wall is substituted by a large steel brick (more heavy than fixed pipe imitator), which is suspended on the soft rubber elements to the holding structure. Short impact is used to excite wideband vibrations in the imitator (in the frequency range of interest).

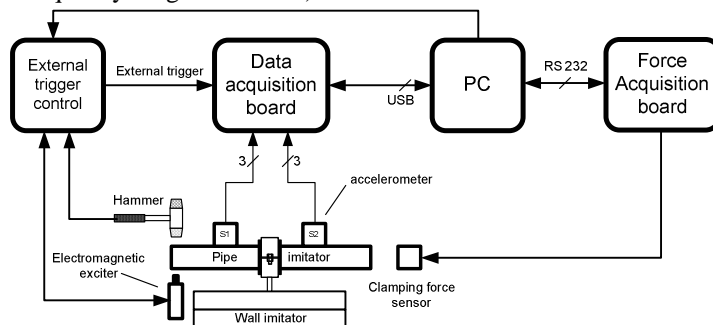

Fig. 7. Connection diagram of the process control and data acquisition unit

For vibration measurements 3-axis accelerometers assembled in Kaunas University of Technology (KTU) were used. Accelerometers were built on the basis of LIS334ALH chip (approx. frequency range from 0 Hz to 1.8 kHz). For better identification of vibration modes several multi-axis sensors could be used during one measurement procedure. Depending on transducer placement, direction of excitation and applied signal processing we can assess transverse, longitudinal or rotating motions of the pipe imitator. Experiments are carried out by using two transducers (S1 and S2), which are located on the different sides with respect to the rotational axis of the pipe imitator. From the resonant curve (Fig. 8.) resonant frequency and bandwidth of the dominant vibration mode are assessed including stiffness and damping characteristics.

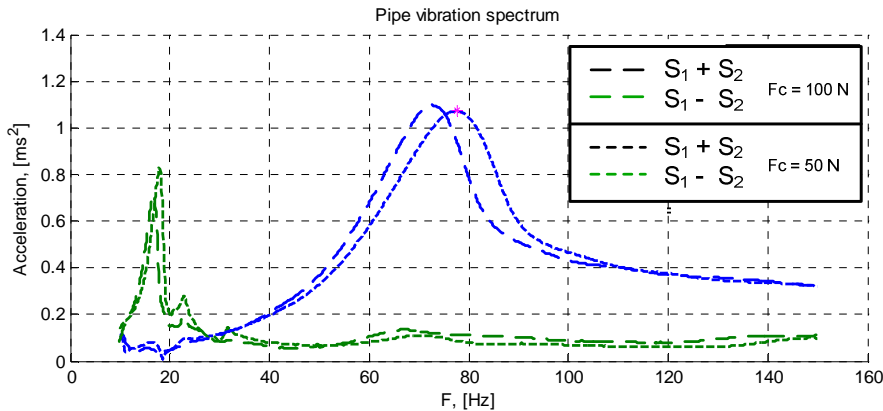

Fig. 8a. Change of resonance curve for two different magnitudes of clamping force (50 N and 100 N) of the pipe holder H1. For longitudinal movement the resonant frequency shifts from 77.7 Hz to 72.6 Hz, for rotational—from 18 H to 17 Hz

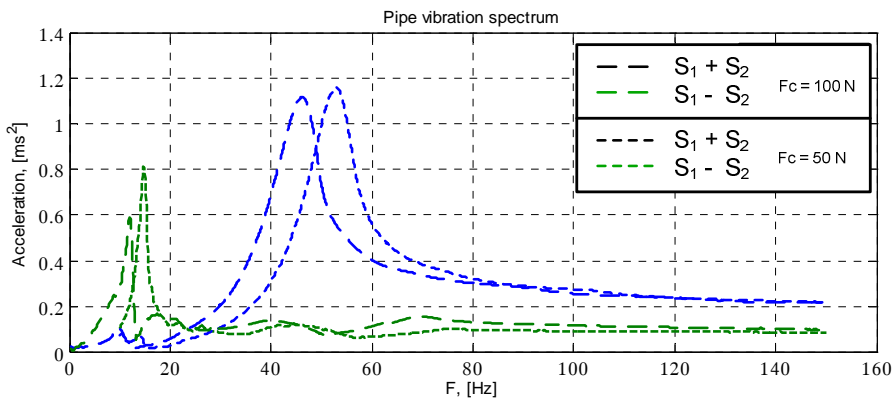
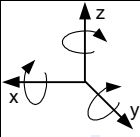
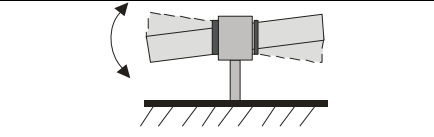
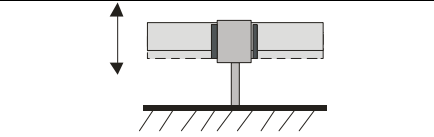

Fig. 8b. Change of resonance curve for two different clamping forces (50 N and 100 N) of the holder H2. For longitudinal movement resonant frequency shifts from 54.2 Hz to 47.1 Hz, for rotational – from 14.7 Hz to 12.9 Hz

Series of measurements were performed to evaluate the same diameter and different model pipe holders (changes due to the different clamping forces, shapes of vibrations, etc.). A couple

of them are listed in Table 1. Usually the stiffness of the pipe holder increases if clamping force is increased (isolation characteristics are getting worse).

Table 1. Dynamic stiffness and damping factors measured by free vibration tests. H1, H2 are the arbitrary pipe holder types, a – clamping force 50 N, b – clamping force 100 N.

								
	Rotational vibrations				Linear vibrations			
	Around Y axis		Around Z axis		Along Z axis		Along Y axis	
	$k_{rot}, \frac{Nm}{rad}$	b_{rot}	$k_{rot}, \frac{Nm}{rad}$	b_{rot}	$k \cdot 10^6, \frac{N}{m}$	b	$k \cdot 10^6, \frac{N}{m}$	b
H1-a	160	0.3	220	0.25	0.58	351	0.79	260
H1-b	195	0.2	268	0.15	0.77	364	1.06	500
H2-a	278	0.37	380	0.3	1.37	731	1.88	1000
H2-b	312	0.34	420	0.25	1.57	870	2.16	1200

Conclusions

The developed measurement system allows execution of experimental analysis in the fixed pipe segment setups that simulate installations in real buildings. Fixing elements of different diameter and material can be tested to obtain more information about characteristic vibration energy transfer mechanisms and vibro-insulating properties.

Dynamic stiffness and damping objectively describe vibro-isolation characteristics of a pipe holder. These characteristics can be evaluated by means of free vibration method.

Main properties of the pipe holder (stiffness and damping) depends on construction of the half rings, insert type, applied clamping force and modes of vibration.

Estimated characteristics enable evaluation of pipe ring transfer function, which represents how vibrations propagate from pipe to the wall.

References

- [1] Romeu J., Jime'nez S., Capdevila R. Noise emitted by water supply installations, 2003. Applied acoustics.
- [2] Malcius M., Augutis V. Measurement of static characteristics of pipe fastening elements // Journal of Vibroengineering // Vilnius: Vibromechanika. ISSN 1392-8716. 2010, Vol. 12, no. 1, p. 75-81.
- [3] Pain H.J. The Physics of Vibration and Waves, 2005 John Wiley & Sons, Ltd.
- [4] Clarence W. de Silva. Vibration Damping, Control and Design, 2005 CRC Press, ISBN 1-4200-5321-3;
- [5] Ramanauskas R., Augutis V., Gailius D. The research system for vibration analysis in domestic installation pipes // Journal of Vibroengineering // Vilnius: Vibromechanika. 2009, Vol. 11, No. 1. ISSN 1392-8716 p. 41-47.